



Motorola Razr/ Razr+ Freedom Micro II Speedbracket

Installation Guide



Kit Components

FREEDOM MICRO II MOTOROLA
RAZR(+) ANGLE BRACKET

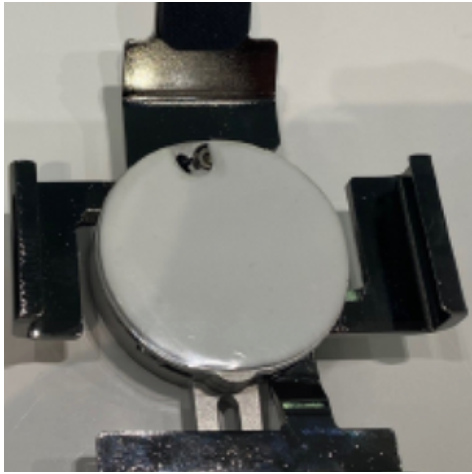

OR

FREEDOM MICRO II MOTOROLA
RAZR(+) BRACKET

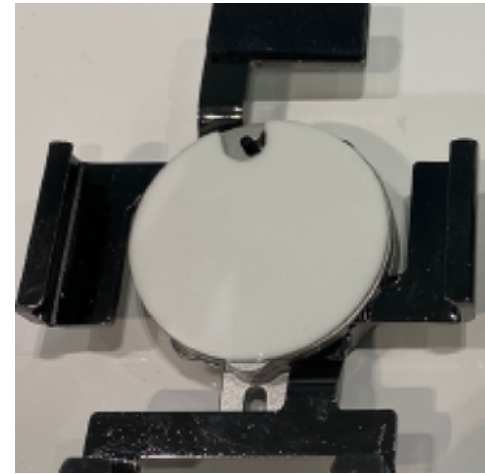

Additional Required Items (not included)

ALCOHOL WIPE



PHONE



FMII TOOL



Step-by-Step Instructions:



Bracket will come pre-spaced! Only follow steps 02-03 if you've accidentally loosened.

STEP 01

Visually confirm small number (2-3 grooves) are visible



STEP 02

If loose, adjust to match Step 01



NOTE: Top & bottom arms shall remain fully collapsed through the installation process!

STEP 03

Once arms are corrected, tighten central screw



Step-by-Step Instructions:

STEP 04

Test Fit.

Place lower edge of device under lower arms.



STEP 05

Test Fit Continued.

Phone should slip past side arms.

If side arms are too tight. Go back to Step 01.



⚠ Do not peel adhesive liner during Step 04 and 05

STEP 06

Clean phone.

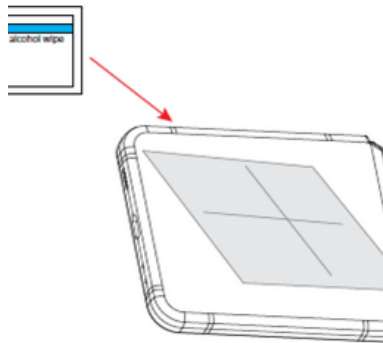

STEP 07

Check clip and charger port alignment.

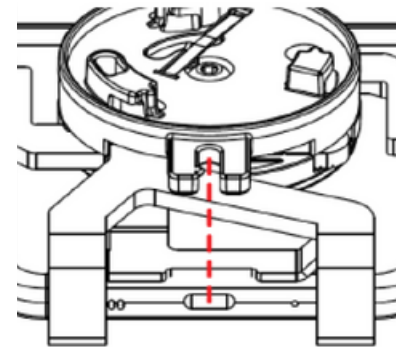

Step-by-Step Instructions:

STEP 08

Remove liner.

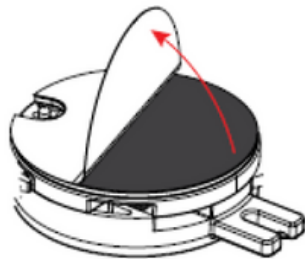

Check alignment before sticking.

STEP 09

Repeat steps 04-05.

Apply pressure.

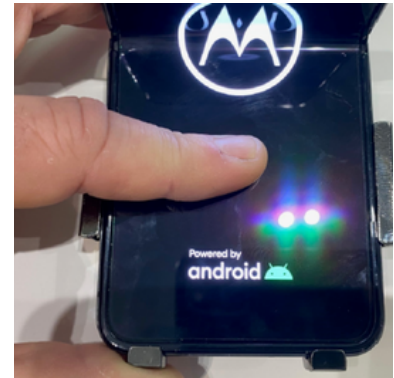

NOTE: Top & bottom arms shall remain fully collapsed through the installation process!

STEP 10

Loosen screws.

Press side arms, tightly.

Tighten central screw.

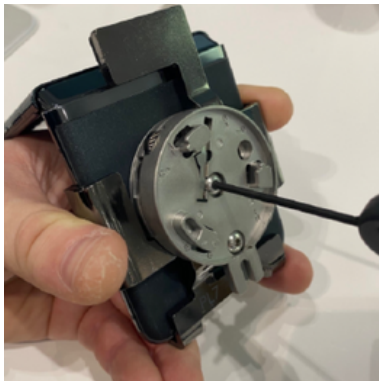

STEP 11

Continue pressing side arms.

Tighten lower screw.



Step-by-Step Instructions:

STEP 12

Click bracket onto the stand.



STEP 13

Plug in phone charging cable.

