

Product Manual for CX FLEX™ 1A

Contents

| | | |
|-----|------------------------|---|
| 1. | Installation | 2 |
| 2. | Key Whitelist | 3 |
| 3. | Merchandising | 3 |
| 4. | Managing Alarms | 4 |
| 5. | Cable Removal | 4 |
| 6. | Remerchandising | 4 |
| 7. | Adding New User Keys | 5 |
| 8. | Deleting Whitelist | 5 |
| 9. | Battery Replacement | 6 |
| 10. | Position Removal | 6 |
| 11. | LED Status Indicators | 7 |
| 12. | Dimensions | 8 |
| 13. | FCC and ISED Statement | 9 |

DO NOT REMOVE FROM STORE



**For additional support, please reach out to our
Contact Center at 800-426-6844**

- 1** If needed, clean the underside surface with an alcohol pad and allow to dry. Place new VHB on the puck.

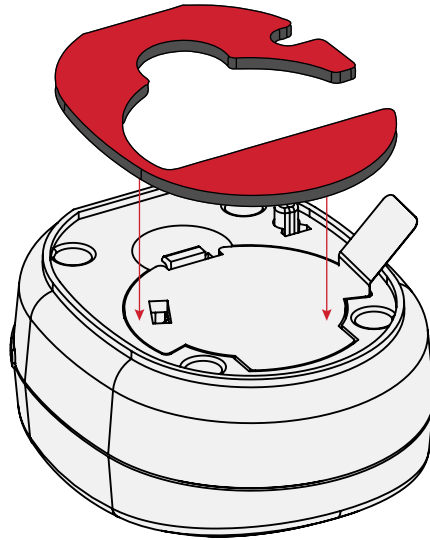

- 2** Clean the desired surface with an alcohol pad allow it to completely dry. Remove pull tab to activate device. Peel the red film from the VHB adhesive.

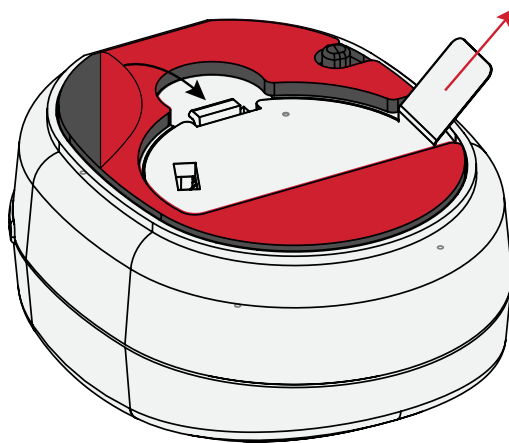

- 3** Press down on the base plate for 10 seconds for full VHB contact. Allow 24 hours for full VHB adhesion.

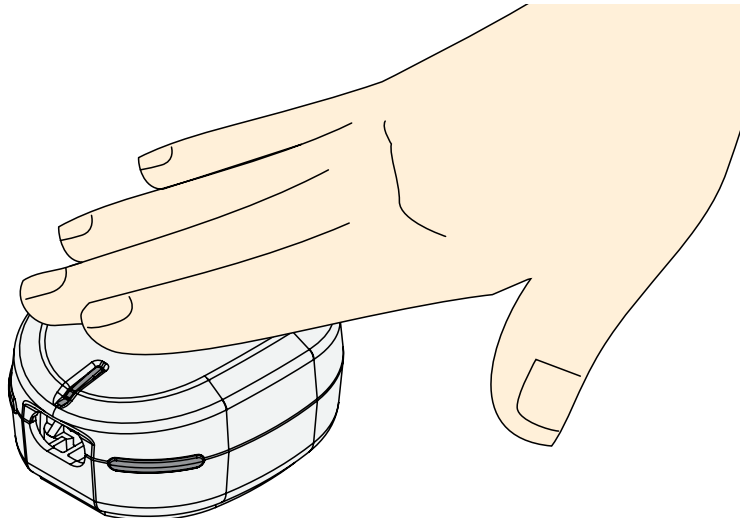

1 Place Authorization Card over the RFID icon to register to system.

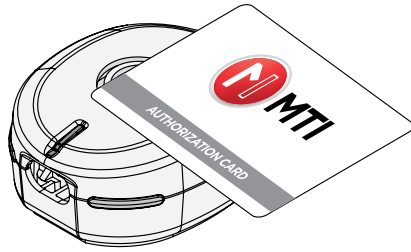

System must be disarmed to perform this operation.

2 Place the User Key you want to add over the RFID icon.

If successful → unit beeps 2 times

Repeat process for all User Keys until they are successfully added.

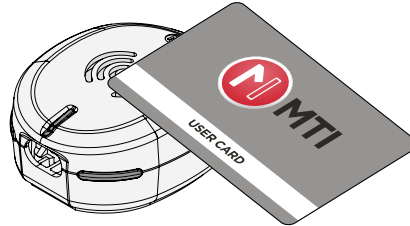

3 To close the whitelist mode, place the Authorization Card over the RFID icon. Whitelist mode will end automatically after 3 minutes of no use.

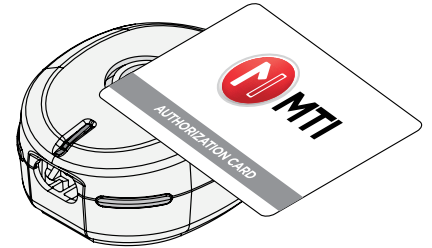

MERCHANDISING

1 Plug the USB-C end of the sensor into the CX Flex until it clicks.

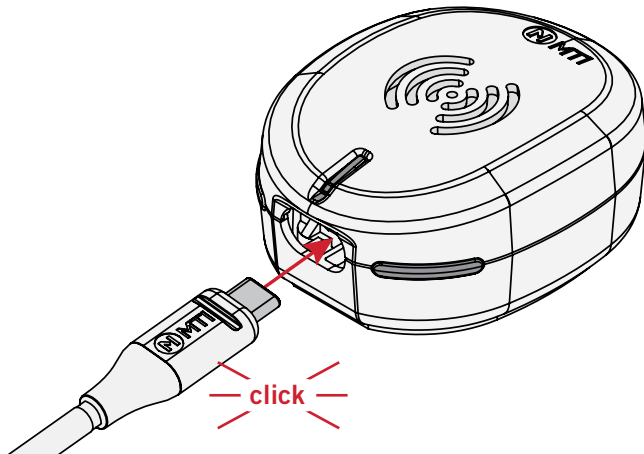

2a **USB-C Sensor:** Insert the other end of the cable into the device.

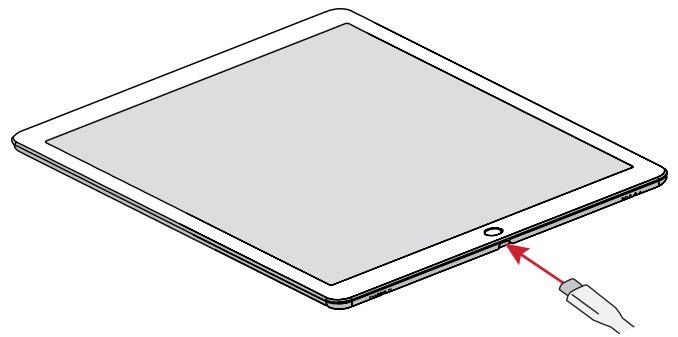

2b **Flexi-Disc Sensor:** Peel the red film from the VHB adhesive and press firmly onto the product for 1 minute if the product surface is curved, or 30 seconds if it is flat.

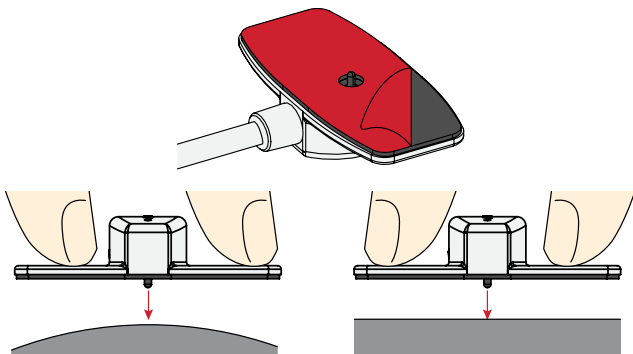

3 System will auto-arm after 1 minute, or arm immediately by holding a whitelisted User Card over the RFID Icon.

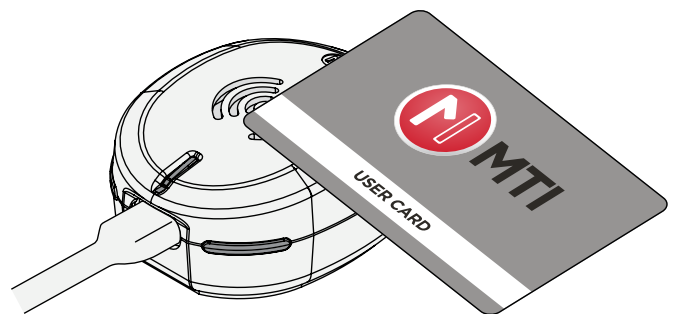

- 1 To silence an alarm, hold the user card over the RFID icon. To disarm after silencing an alarm, hold the user card over the RFID icon for 5 seconds.

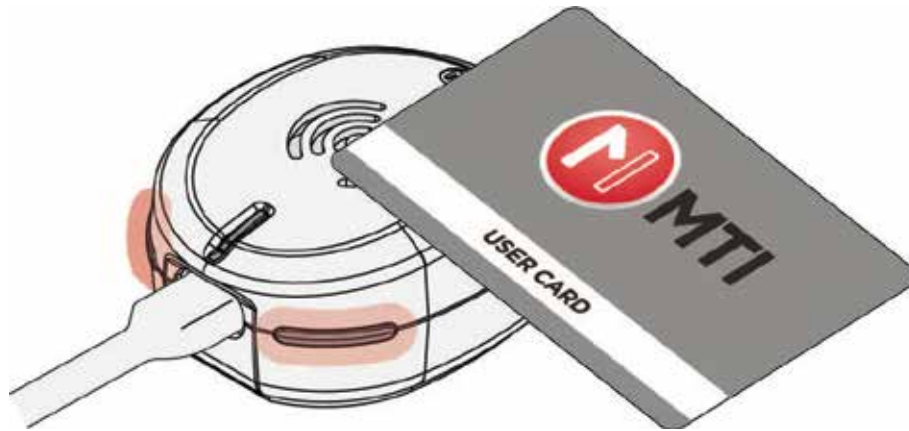

CABLE REMOVAL

- 1 Insert a corner of the RFID card into the slot and press down until the cable detaches.

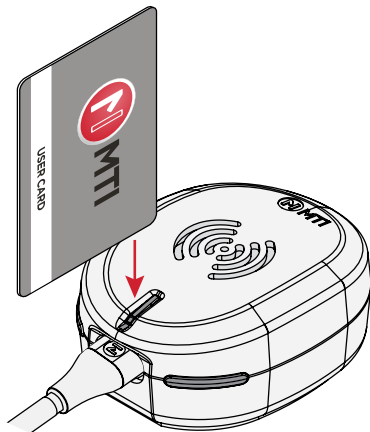

- 2 Remove the cable.

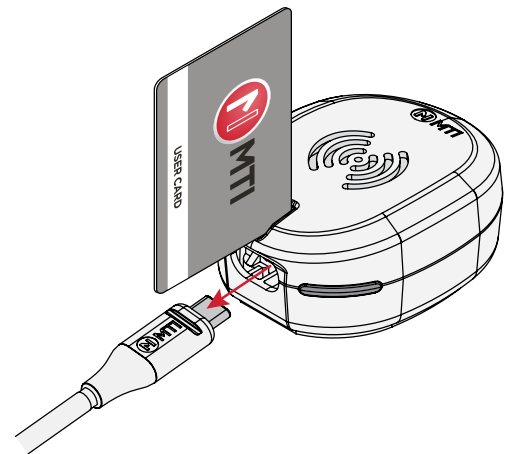

REMERCHANDISING

- 1 From an armed state, place the user key over the RFID icon to disarm the system. LED will be flashing red, 2 times every 10 seconds. Then remove the cable. Once the cable is removed, the LEDs will stop flashing.

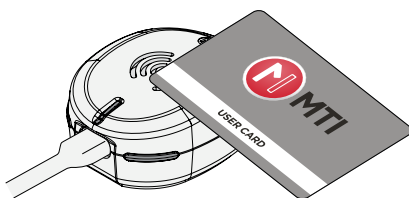

- 2 Insert new cable until it clicks.

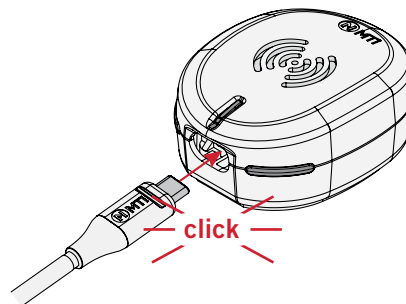

- 3 Re-arm by holding user card over RFID icon or system will auto-arm after 1 minute. LEDs will be OFF when the system is armed.

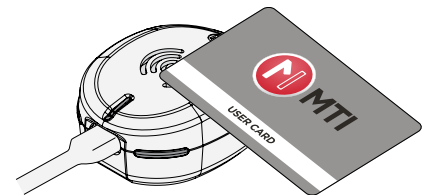

1 From an armed state, place the user key over the RFID icon to disarm the system. LED will be flashing red, 2 times every 10 seconds.

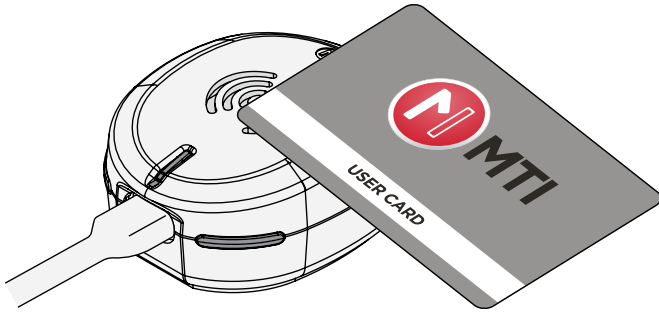

2 Place Authorization Card over the RFID icon. Follow Key Whitelist process starting on page 3.

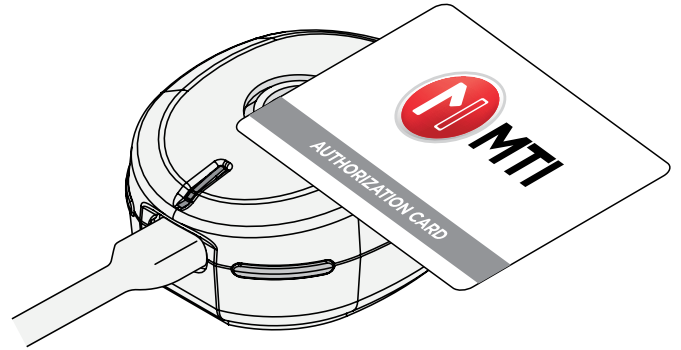

DELETING WHITELIST (This will delete all User Keys from the system.)

1 From an Armed state, place the User Key over the RFID icon to disarm the system. LED will be flashing red, 2 times every 10 seconds.



2 Hold down the Authorization Card for 5 seconds, and a chirping sound will start.

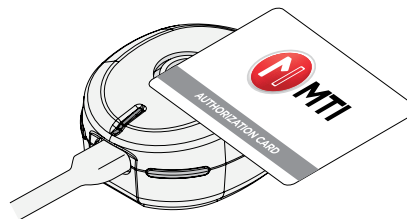

3 Place the Authorization Card over the RFID icon AGAIN during the 10 second chirp sequence.
If successful → unit beeps 2 times and chirps stop

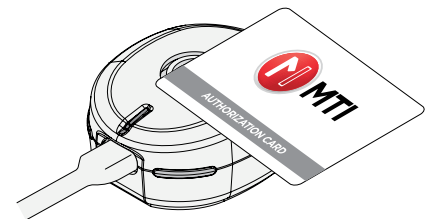

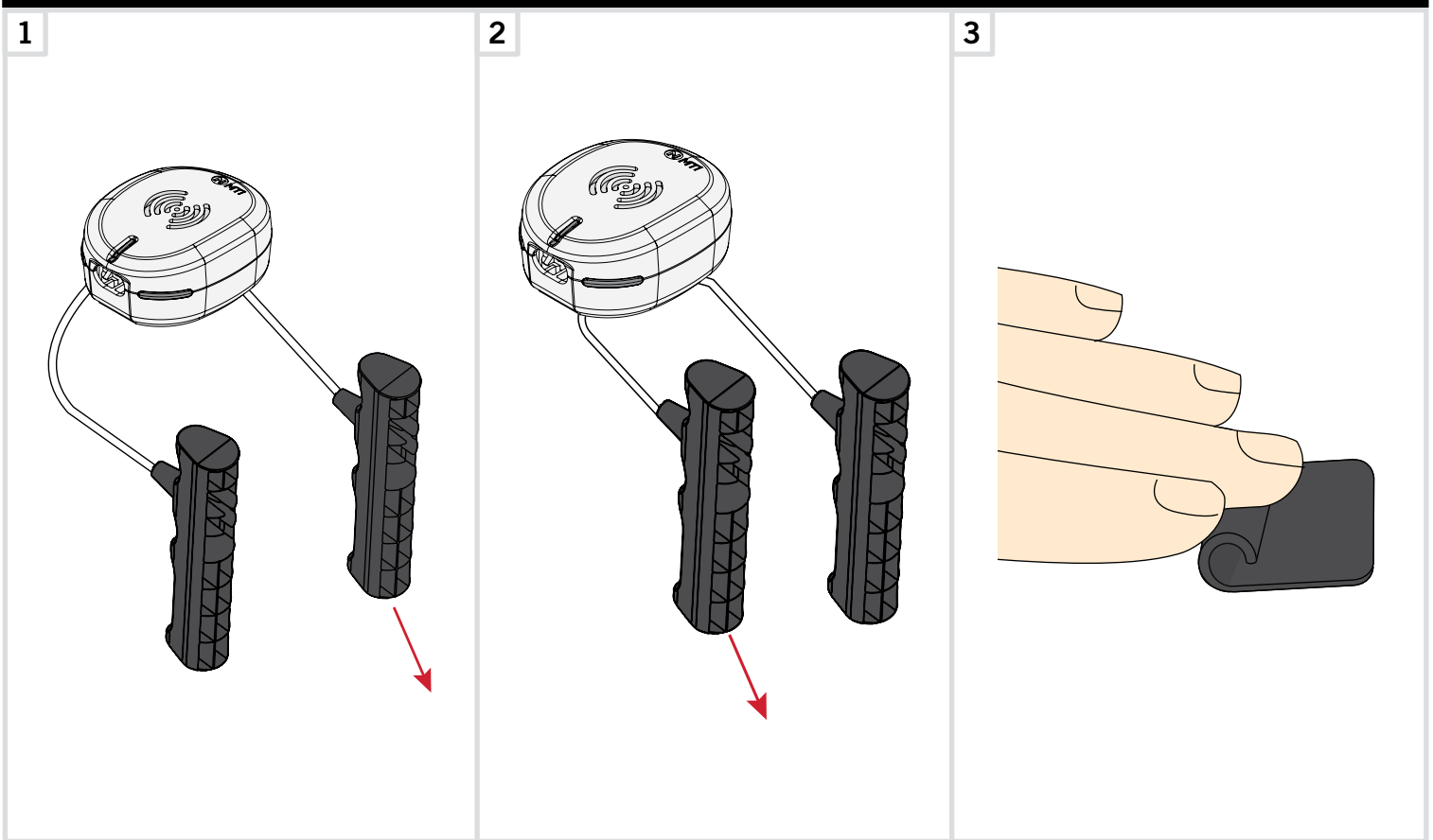

BATTERY REPLACEMENT

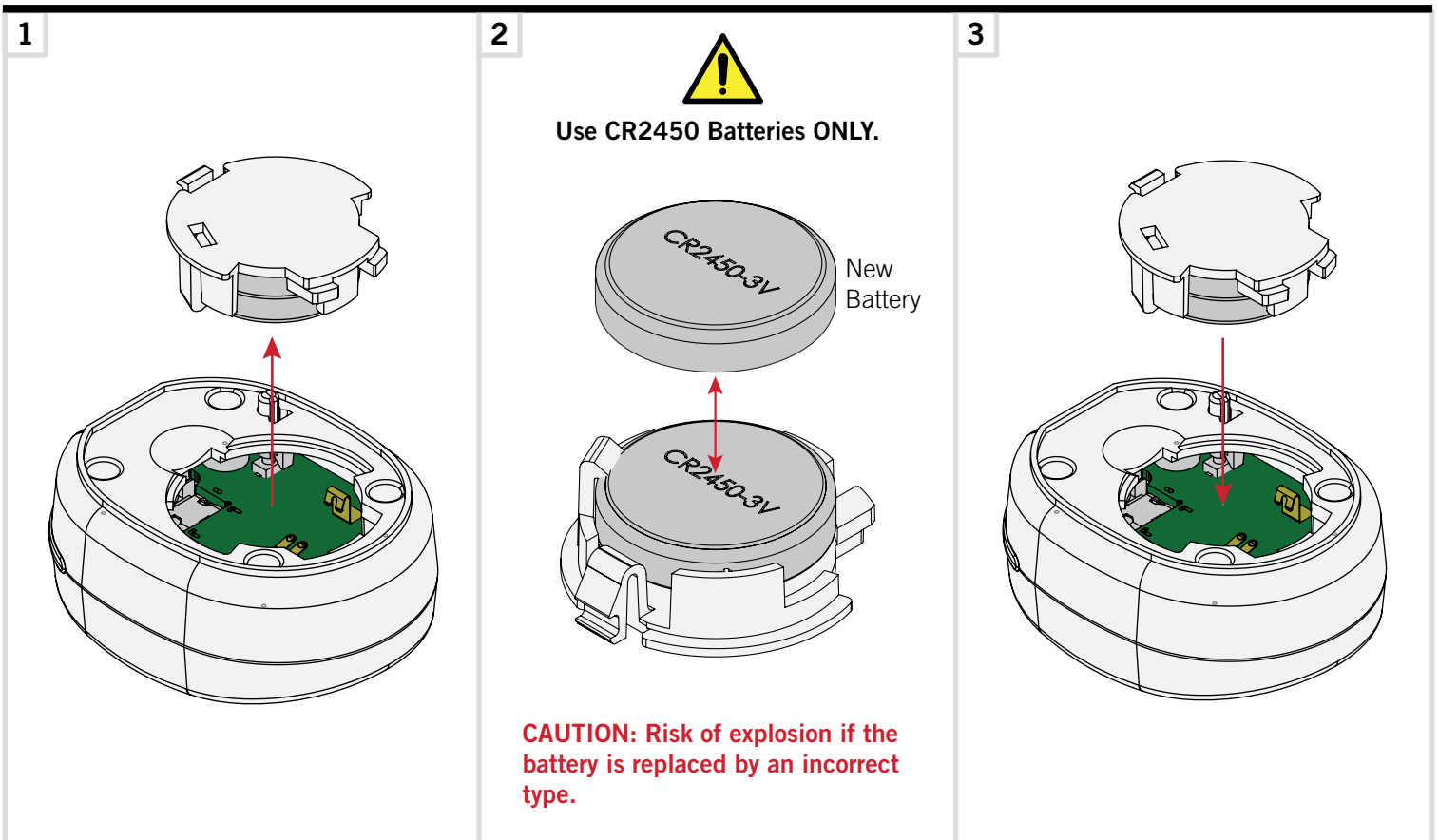

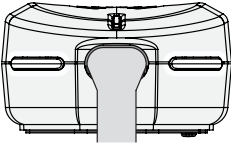
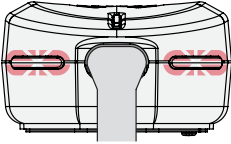
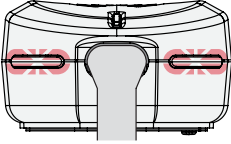
| Visual Reference | System Status | Condition | Solution |
|--|---|--|--|
|  | LED is OFF. | <ol style="list-style-type: none"> 1. Factory Reset 2. No product merchandised or not properly merchandised 3. Armed 4. Battery needs to be replaced | <ol style="list-style-type: none"> 1. No User or Authorization cards are registered, LEDs will not flash when properly merchandised, system will not arm -- Create Whitelist per Page 3. 2. Check connections for proper merchandising. 3. System is armed. 4. Replace battery with CR2450 |
|  | LED is flashing red, 2 times every 10 seconds. | Disarmed, but able to be armed | System is disarmed and is ready to re-arm. |
|  | LED is continuously flashing red, 2 times every 10 seconds. | Alarming | System is alarming and requires immediate attention. |

WARNINGS



1. For indoor use only, shall not be exposed to dripping or splashing.
2. Do not expose to excessive heat sources, sunshine, fire or the like.
3. The socket-outlet shall be installed near the equipment and shall be easily accessible.
4. No user replaceable parts inside, refer servicing to manufacturer specified agency or qualified service personnel.
5. Only use accessories/battery specified by the manufacturer.



Disposal:

All electrical and electronic products including batteries should be disposed of separately from the municipal waste stream via designated collection facilities appointed by the government or the local authorities.

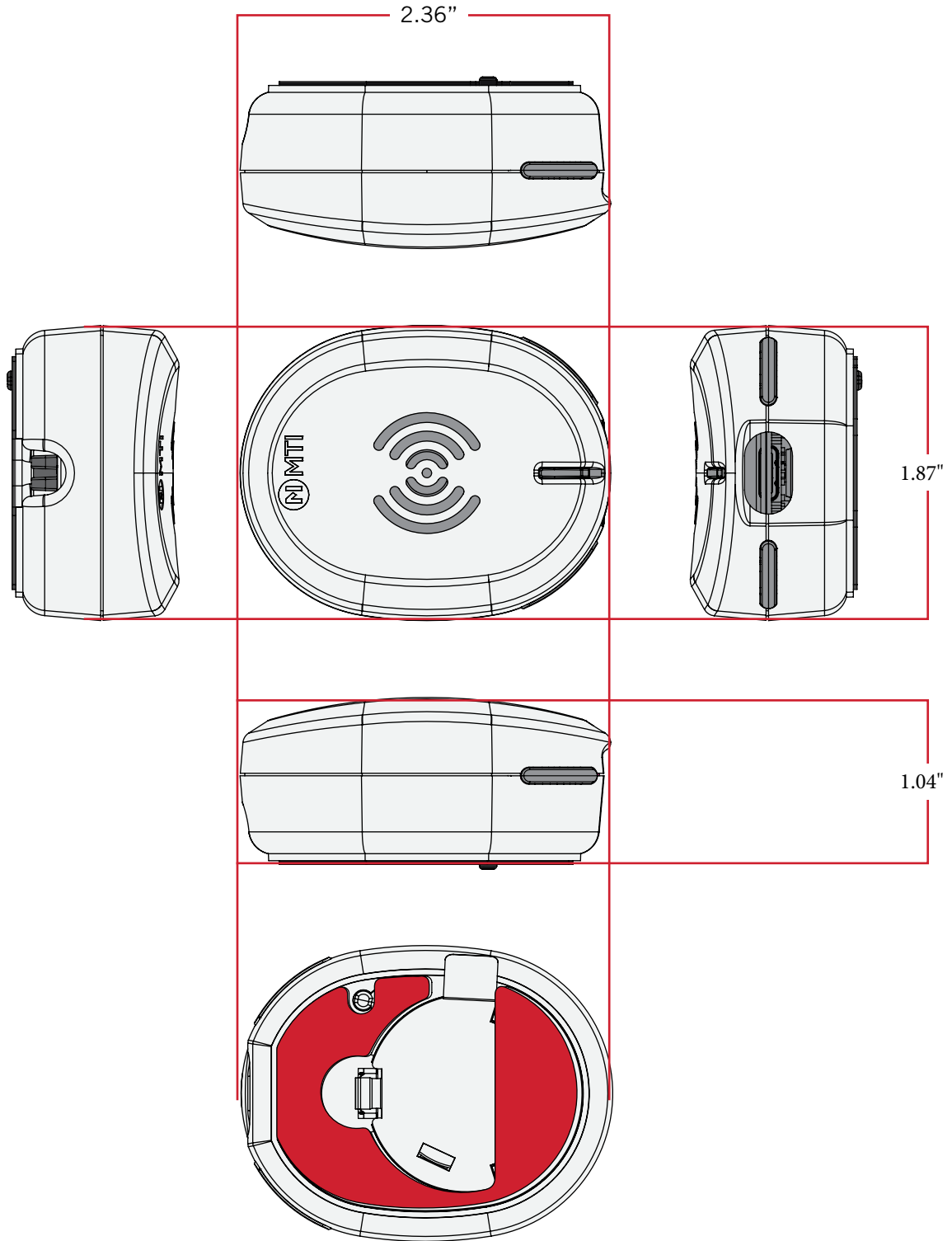

FCC ID: 2AA2X-15000221

Model: CX Flex 1A

FCC Statement

This device complies with Part 15 of the FCC Rules.

Caution: If any changes or modifications not expressly approved by the party responsible for compliance could void the user's authority to operate the equipment.

Operation is subject to the following two conditions: (1) This device may not cause harmful interference, and (2) This device must accept any interference received, including interference that may cause undesired operation.

The grantee is not responsible for any changes or modifications not expressly approved by the party responsible for compliance. Such modifications could void the user's authority to operate the equipment.

The RF Exposure Compliance distance is 20 millimeters.

NOTE: This equipment has been tested and found to comply with the limits for a Class B digital device, pursuant to part 15 of the FCC Rules. These limits are designed to provide reasonable protection against harmful interference in a residential installation. This equipment generates, uses and can radiate radio frequency energy and, if not installed and used in accordance with the instructions, may cause harmful interference to radio communications. However, there is no guarantee that interference will not occur in a particular installation. If this equipment does cause harmful interference to radio or television reception, which can be determined by turning the equipment off and on, the user is encouraged to try to correct the interference by one or more of the following measures:

- Reorient or relocate the receiving antenna.
- Increase the separation between the equipment and receiver.
- Connect the equipment into an outlet on a circuit different from that to which the receiver is connected.
- Consult the dealer or an experienced radio/TV technician for help.

ISED Certification Number: 24439-15000221

Model: 165-00746

ISED Statement

This device complies with Innovation, Science and Economic Development Canada licence-exempt RSS standard(s). Operation is subject to the following two conditions: (1) this device may not cause interference, and (2) this device must accept any interference, including interference that may cause undesired operation of the device.

CAN ICES-3(B)/NMB-3(B)

Le présent appareil est conforme aux CNR Innovation, Sciences et Développement économique Canada applicables aux appareils radio exempts de licence. L'exploitation est autorisée aux deux conditions suivantes:

(1) il ne doit pas produire de brouillage et (2) l'utilisateur du dispositif doit être prêt à accepter tout brouillage radioélectrique reçu, même si ce brouillage est susceptible de compromettre le fonctionnement du dispositif.

CAN ICES-3(B)/NMB-3(B)

The device meets the exemption from the routine evaluation limits in section 2.5 of RSS 102 and compliance with RSS-102 RF exposure, users can obtain Canadian information on RF exposure and compliance.

Le dispositif rencontre l'exemption des limites courantes d'évaluation dans la section 2.5 de RSS 102 et la conformité à l'exposition de RSS-102 rf, utilisateurs peut obtenir l'information canadienne sur l'exposition et la conformité de rf.

This transmitter must not be co-located or operating in conjunction with any other antenna or transmitter. This equipment should be installed and operated with a minimum distance of 20 millimeters between the radiator and your body.

Cet émetteur ne doit pas être Co-placé ou ne fonctionnant en même temps qu'aucune autre antenne ou émetteur. Cet équipement devrait être installé et actionné avec une distance minimum de 20 millimètres entre le radiateur et votre corps.

Technical Data

Model: 165-00746

| | |
|------------------------|--------------------------|
| Operating Frequency: | 125kHz |
| Operating Temperature: | 0° C to 40° C |
| Max Power: | 125kHz: <42dBuA/m at 10m |

Mobile Technologies Inc. - 1050 NE 67th Ave, Hillsboro, OR 97124